

ストレート

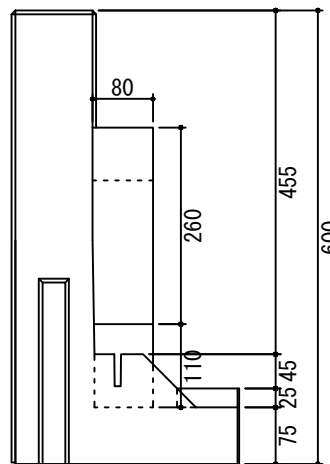

外コーナー

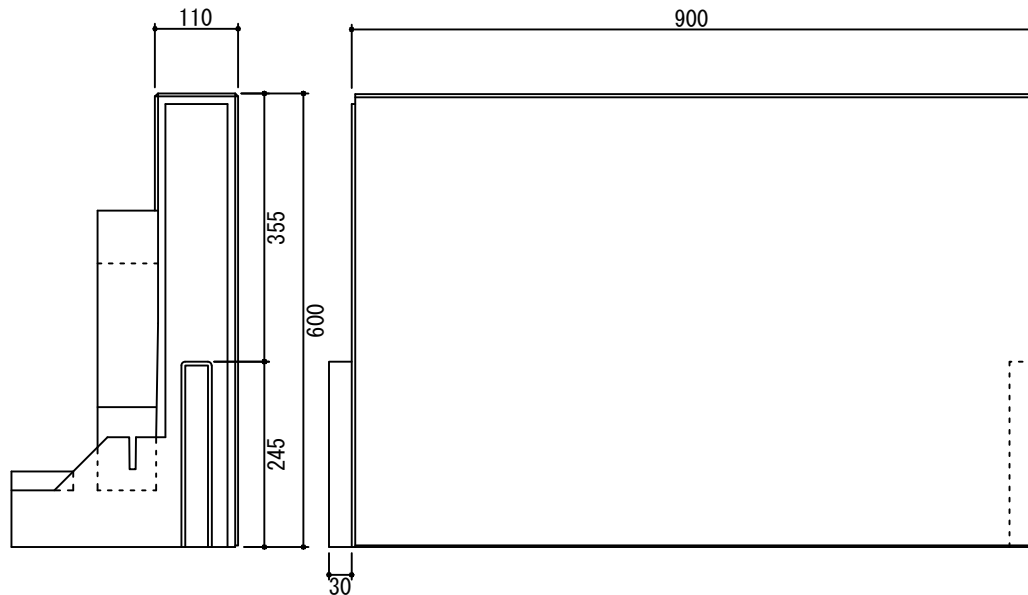
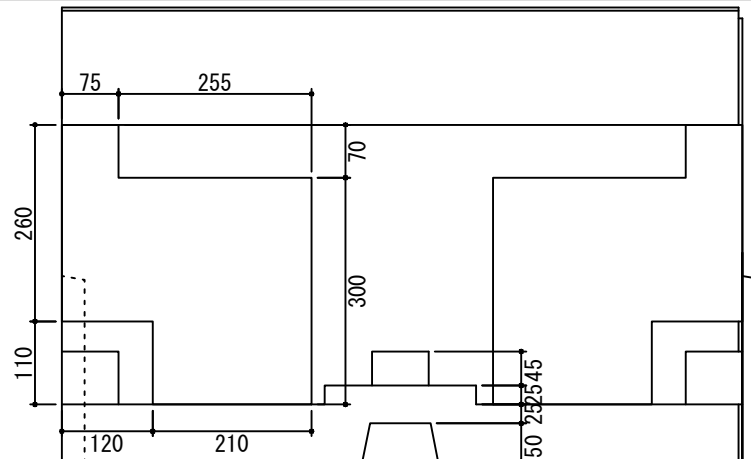
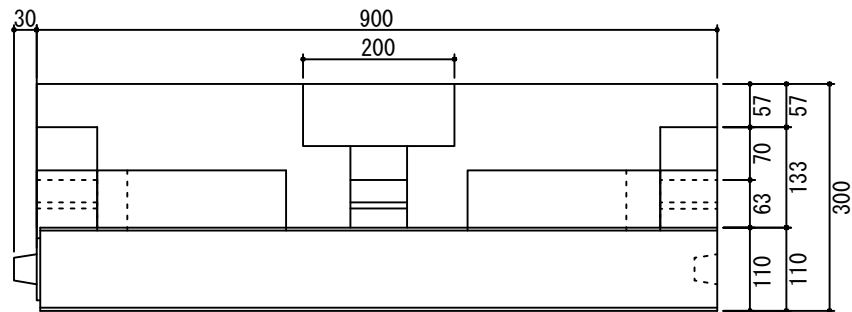
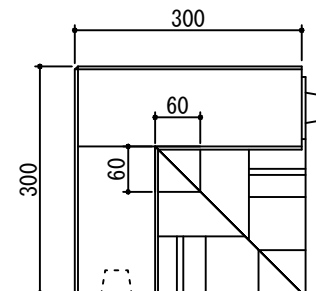

内コーナー

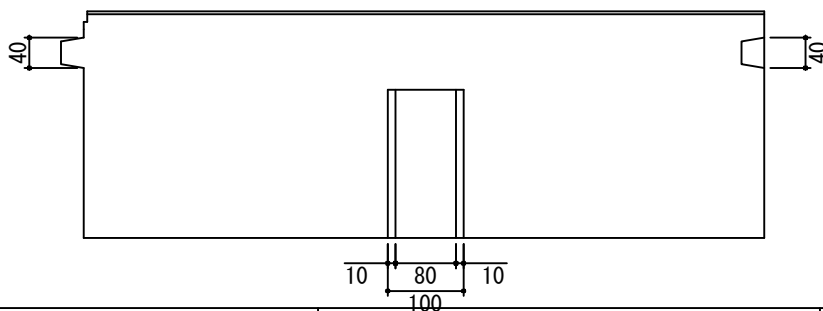
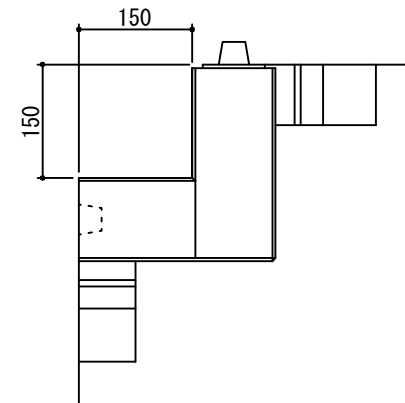

ビルマテル株式会社

図面名称 フェザーストーンウォールH600

縮尺 1/10 (A4)